

FORI ESAGONALI
M5 DIAM.7,2MM

FORI ESAGONALI
M5 DIAM.7,2MM

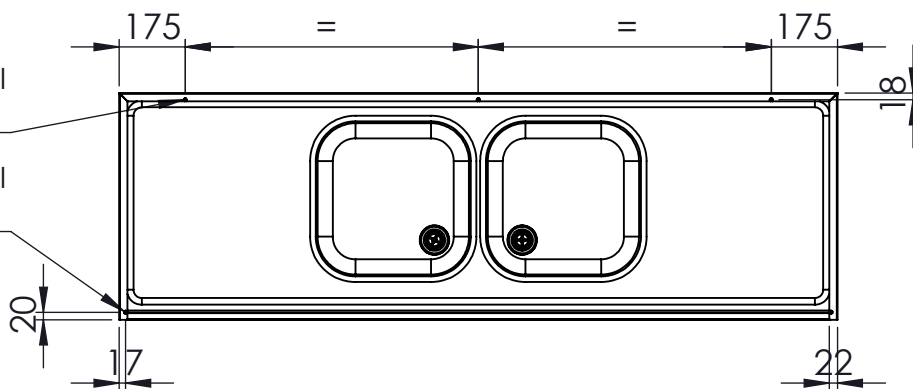

DISEGNATO	
DATA	11/01/2024
PESO	23688.54

CODICE: **MI00**



CONFIGURAZIONE: **L:1900 P:600**

SCALA: 1:20

A4

FOGLIO 1 DI 1